

# Weller®

## WD2M / WD2000M

USA Operating Instructions



# Table of contents

# Page

1. WD2M Detailed View	1
2. Cautions / Warnings	2
3. Description	2
4. Technical data / LCD Display	3
5. Placing into Operation	4
6. Channel Selection	4
7. Special Functions	5
8. USB Interface	9
9. Operating Guidelines	9
10. Accessories	9
11. Packing List	9
12. WMRP Soldering Iron	10
13. RT Style Tips	12-13
14. WMRT Tweezers	14
15. WMRT Tips	16
16. WD2M Circuit Diagram	18
17. WD2M Exploded View	19

## 1. WD2M Detailed View

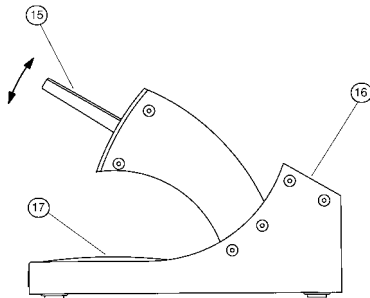
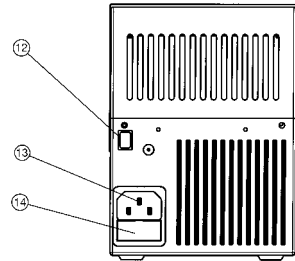
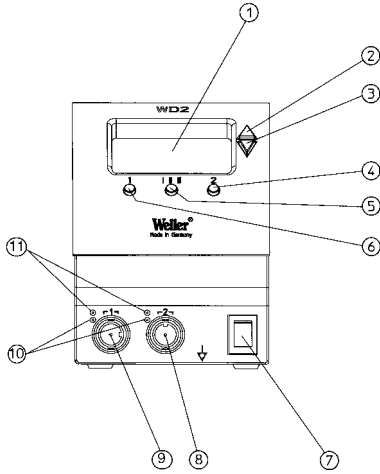

1. LCD Display
2. UP Scroll Key
3. DOWN Scroll Key
4. Radio Button / Channel 2 Selector
5. Radio button ( I - II - III ) Selector
6. Radio Button / Channel 1 Selector
7. Power Switch
8. Soldering Iron Receptacle Channel 2
9. Soldering Iron Receptacle Channel 1
10. LED Channel Selection Indicator
11. LED Heat Indicator
12. USB Port
13. Power Unit Receptacle
14. Primary Fuse
15. Soldering Tool Holder
16. Soldering Stand (Tip Storage)
17. Tray / Sponge

Thank you for placing your trust in our company by purchasing the Weller WD2M / WD2000M. This product meets or exceeds the requirements established by Weller for superior performance, versatility and quality.



## 2. Cautions! / Warnings!

Please read these Operating Instructions and the attached Safety Information carefully prior to initial operation. Failure to observe the safety warnings may result in accident, injury, or risk to health.

The manufacturer shall not be liable for damage resulting from misuse or unauthorized alterations of the equipment.

Warning: This product when used for soldering and similar applications, produces chemicals known to the State of California to cause cancer and birth defects or other reproductive harm.

### Safety Information:

- Always place the soldering iron in its original holder
- Remove all inflammable objects from the proximity of the hot soldering tool.
- Use suitable protective clothing to prevent the risk of burns associated with molten solder.
- Never leave a hot soldering iron unattended.
- Never work on electrically live circuits or components.
- Always wear eye protection when working with soldering and desoldering applications.

The Weller microprocessor-controlled soldering station WD2M / WD2000M corresponds to the EC Declaration of Conformity in accordance with the basic safety requirements of Directives 89/336/EEC and 73/23EEC.

## 3. Description

### 3.1 Control unit

The microprocessor-controlled 2-channel soldering station WD2M is part of a generation of devices developed for industrial electronic production, including repair and laboratory applications. Digital electronic controls, a precision sensor and heat transfer technology in the soldering tool provides precise temperature control of the soldering tip.

Fast and precise sensor sampling in the closed loop control provides tip temperature accuracy and maximum temperature control under load. The soldering tools are recognized automatically by the WD2M and the appropriate control parameters are set.

A Factory Control Check function, an Offset value input option, programmable temperature decrease (Setback) along with Standby and Lock functions enhance the functionality of this unit.

The desired temperature can be set in the range 150 °F – 850 °F (50 °C – 450 °C). “Set” and “Read” (actual tip temperature) values are displayed digitally. Three Radio Buttons (4) (5) (6) are used for selection of fixed/preset temperatures. The Heater Control Indicator flashes (“ $\curvearrowright$ ” symbol in the display) when the “Set” temperature is reached.

### 3.2 USB Port

The WD2M has a USB port for remotely controlling the soldering station and temperatures can be read and printed using a standard PC and PC software.

### 3.3 Tool Stand

When not in use, the soldering iron should always be placed in the Tool Stand.

The Tool Holder (14) for the soldering iron has four different settings, (30-80°) and can be moved to an operator's preferred position without the use of tools. Areas have been provided on the rear (15) of the Tool Stand for placing the soldering tip when not in use. The base of the Tool Stand contains a sponge (16) for cleaning the soldering tips. (Note: LT tips require tip retainer for storage in Tool Stand.)

### 3.4. Soldering irons

#### WMRP

An extremely powerful 40 W fine soldering iron with the heating system integrated into the soldering tip. Thanks to a plug-in system, the soldering tip can be changed without tools. The soldering tip temperature is reached rapidly and controlled precisely. Thanks to a sensor installed in the handle, the soldering iron is shut off automatically when it is placed in the WMRH holder. Note: Minimum Tool Temperature 200 °F 100 °C.

#### WMRT

The Weller WMRT Tweezers are designed for rework and repair of precision SMT electronic devices. The desoldering tip set can be quickly and easily changed without the use of tools. The tips are pre-aligned and additional alignment is not required. The integrated (2 X 40 W) heating elements ensure that the desoldering tip temperature is reached very quickly and controlled precisely. The desoldering tweezers are switched off automatically when placed in the WMRTH tool holder. Note: Minimum Tool Temperature 200 °F 100 °C.

**WP80 (Optional):**

The WP80 Soldering iron is characterized by fast heat-up and precise control of the soldering tip. Due to its slim design, 80W heater output and short reach (tip to grip), this tool can be used for a variety of applications, from extremely fine soldering tasks to those requiring high temperatures.

**WMP (Optional):**

The WMP Micro Soldering Iron's very fast heat-up time and short reach (tip to grip), makes it ideal for precision SMT electronics. The short distance between the grip and soldering tip makes precise handling of the 65W soldering iron possible while performing very fine soldering tasks.

**WTA50 (Optional) :**

The WTA50 Desoldering Tweezers were designed specifically for desoldering SMT components. Two heating elements (2 x 25W), each with its own temperature sensor, maintain the same temperature on both tweezer tips.

**WSP150 (Optional) :**

The WSP150 Soldering iron is an especially powerful tool for soldering tasks with extremely high heat requirements. ( Note: Only one channel is active when this Soldering iron is used. )

See Accessories for a list of other soldering tools that can be connected.

## LCD Display

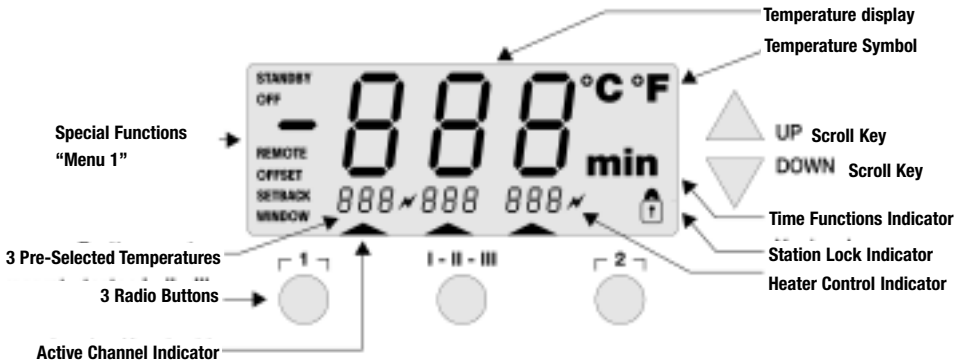

### 4. Technical Data

Dimensions:	5.27" L x 4.27" W x 5.77" H; (134mm L x 108mm W x 147mm H)
Primary voltage:	120 VAC / 50/60 Hz
Power Input:	85 Watts
Power Output:	24VAC
Fuse (10):	T1.0A (120 VAC) (5 x 20mm)
Temperature Control:	150 °F – 850 °F (50 °C – 450 °C); WSP150 : 999 °F ( 550 °C ) WMRP and WMRT Tools - 200 °F – 850 °F (100 °C – 450 °C)
Temperature Accuracy:	±17 °F (±9°C)
Temperature Stability:	±9 °F (±5°C)
Meets or Exceeds:	IPC / EIA J-STD-001C (Appendix A ) Commercial Soldering Standard ( Specific to WMRP / WMRT Soldering and Desoldering Tools )
Tip to Ground Resistance	< 2 Ω ( Specific to the WSP80 / WP80 / WMP / WTA50 Soldering / Desoldering Tools )
Tip to Ground Millivolt Potential	< 2 mV ( Specific to the WSP80 / WP80 / WMP / WTA50 Soldering / Desoldering Tools )

## 5. Placing into Operation

Take care when unpacking the unit and accessories. Place the soldering tools in the safety rest. Insert the soldering iron plug into the connection socket (8) and (9) of the control unit and lock by turning slightly to the right. Verify the supply voltage matches the specification on the Base Unit Label and that the Power Switch (7) is Off. Connect the control unit to the receptacle (12) on the rear of the control unit and plug into a properly grounded receptacle. Switch On the unit at the Power Switch (7). The unit performs a self-test when it is switched "On", whereby all LCD Icons are briefly displayed (1).

Following this, the "Set" temperature of the active channel is displayed for a brief period. The electronic system then switches automatically to the "Read" value. The "↗" symbol appears and the three fixed temperatures of Radio Buttons 1, I-II-III, and 2 are displayed. The "↗" symbol serves as a Heater Control Indicator. The "Set" temperatures for channel 1 and 2 appear in small form in the display. The "Active" channel is labeled with an arrow underneath it. In addition to this, the displayed channel is indicated by a red LED next to the connection socket. The "↗" symbol and the green LED on the connection socket are used as a visual control check. Flashing indicates the "Set" temperature has been reached and the tool has stabilized.

## 6. Channel Selection

When the channel selection Radio Button 1 or 2 is depressed, the display shows the "Set" value of the selected channel. The active channel in the display is indicated with an arrow underneath it. In addition to this, the displayed channel is indicated by a red LED over the connection socket.

The displayed channel can be switched off by simultaneously pressing the UP and DOWN buttons (2) (3). This is confirmed in the display with OFF.

To activate a deactivated channel, select it using the channel selection button, if necessary, and simultaneously press the UP and DOWN buttons (2) (3) to switch it on. The actual value appears in the display.

### 6.1 Temperature setting

#### 6.1.1 Setting Temperature with Up/Down Scroll Keys

As a rule, the main display (1) shows the tip temperature ("Read") value. By depressing the UP or DOWN Scroll Keys (2 & 3), the display switches to the currently "Set" value. The temperature symbol flashes °F (or °C).



The "Set" value can now be changed by tapping or holding in the UP or DOWN Scroll Key (2) (3). If the Scroll Key is held depressed, the "Set" value changes rapidly. Approximately 2 seconds after the Scroll Key is released, the display switches automatically back to the "Read" value.

#### 6.1.2 Setting Temperature with the Radio Buttons 1, I-II-III, 2

The "Set" value for the temperature can be changed via the three Radio Buttons 1, I-II-III, 2.

Default settings:

1	300 °F ( 150 °C)
I-II-III	662 °F ( 350 °C)
2	716 °F ( 380 °C).

By depressing a Radio Button, the pre-selected value for that button now becomes the "Set" temperature. The new value appears for Approximately 2 seconds in the display and the temperature symbol flashes °F (or °C). The display then switches back automatically to the



"Read" value.

#### 6.1.3 Changing Preset Values of Radio Buttons 1, I-II-III, 2

The 3 Radio Buttons 1, I-II-III, 2 can be preset with temperature values as desired.

Depress the UP or DOWN Scroll Key to set a desired temperature (see 6.1.1) in the large display. The °F (or

°C) temperature symbol flashes.

Next, depress and hold the desired Radio Button 1, I-II-III or 2. While the button is depressed, the small display assigned to the Radio Button also flashes and, after 3 seconds, accepts the value of the large display.

Release the Radio Button.

Setting a Radio Button to a low temperature gives you the option of manually and quickly decreasing temper-



ature when the soldering iron is not being used.

## 7. Special functions

The special function are split in two menu sections.

Special functions menu 1: often used functions like STANDBY, OFFSET, SETBACK, ...

Special functions menu 2: Calibration function, Remote

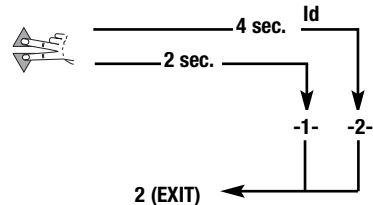

### 7.1 Special functions menu 1

Select the desired channel (CH1 or CH2) for inputting the special functions. If the **UP** and **DOWN** buttons are pressed simultaneously, after approx. 2 seconds the menu selection for the special functions is activated and - I - appears in the display, release buttons.

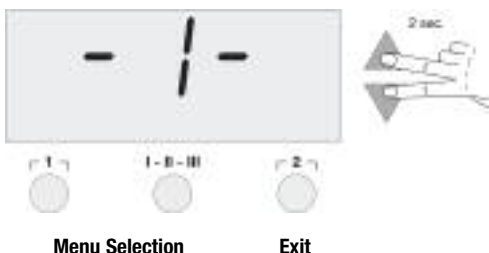

The following set-

tings are possible:

OFFSET, STANDBY, WINDOW (temperature settings);  
SETBACK, OFF (time settings); Lock function (On/Off);  
Temperature scale ( °F / °C ).

Radio Buttons 1 and I-II-III are used for menu item selection.

Radio Button 2 is used to exit the menu.

### Resetting the Station to Factory Settings:

Depress and hold Radio Button 2. Then depress the **UP** and **DOWN** Scroll Keys at the same time. "FSE", "Factory Setting Enabled" appears in the display. The soldering station is now reset to its factory default settings.

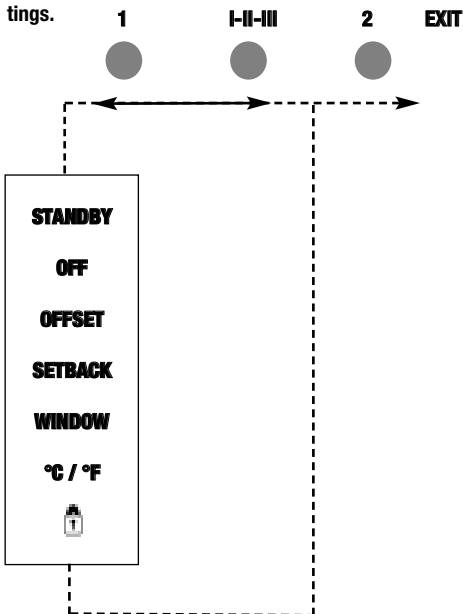

#### 7.1.1 Standby Temperature

When the Setback time has elapsed, the "Set" temperature is decreased automatically to the Standby value. The "Read" temperature is displayed (flashing) and "STANDBY" appears in the display. The Standby temperature can be set in the range ( 200 - 600°F/100 - 300°C ).

Adjust the standby temperature with the **UP** or **DOWN** Scroll Keys.

Switch to the previous menu item with Radio Button 1. Switch to the next menu item with Radio Button I-II-III.



### 7.1.2 Auto Off Time ("OFF")

When the soldering tool is not in use, it is automatically switched off after the "OFF" time has elapsed. The Auto Off time can be set from 0 – 999 minutes. With a setting of "0 min", the Auto Off function is disabled. Auto Off is carried out independently of the Setback function. The "Read" temperature is displayed (flashing) and may be monitored as a decreasing heat indicator; "OFF" appears in the display. Below 122°F (50°C), a flashing dash appears in the center of the display.

Change the "OFF" time with the **UP** or **DOWN** Scroll Keys.



Switch to previous menu item with Radio Button 1.  
Switch to next menu item with Radio Button I-II-III.

### 7.1.3 Temperature Offset

The actual soldering tip temperature can be changed  $\pm 72^\circ\text{F}/\pm 40^\circ\text{C}$  by the input of a temperature offset. The Offset function is used to match the station display to the tip temperature when measured with an external instrument.

Change the "Offset" value with the **UP** or **DOWN** Scroll Key.



Switch to previous menu item with Radio Button 1.  
Switch to next menu item with Radio Button I-II-III.

### 7.1.4 Setback Time

If the soldering tool is not being used, the temperature is decreased automatically to Standby temperature (see 7.1.1) after the specified Setback time has elapsed. The Setback time, after which the soldering unit switches to Standby mode, can be set from 0 – 99 minutes. With a setting of "0 min", the Setback function is switched Off. The Setback status is indicated by a flashing "Read" temperature and "STANDBY" appears in the display. Depress the **UP** or **DOWN** Scroll Key to end "Setback" and return the station to the "Set" temperature.

Change the "Setback" time with the **UP** or **DOWN** Scroll Key.



Switch to previous menu item with Radio Button 1.  
Switch to next menu item with Radio Button I-II-III.

### 7.1.5 Window Function

The Window Function allows the temperature to be adjusted within a range (max.  $\pm 180^\circ\text{F}$  ( $\pm 99^\circ\text{C}$ )), above and below the Locked temperature (see 7.1.7). The Locked temperature thus represents the middle of the settable temperature range.

**Note:** To utilize the window function, the station has to first be placed into Lock mode.

Use the **UP** / **DOWN** Scroll Keys to change the range of temperatures allowed within the operating "window".

Switch to previous menu item with Radio Button 1.



Switch to next menu item with Radio Button I-II-III .

### 7.1.6 Switching Temperature Scales °F/°C

Use the UP or DOWN Scroll Key to switch between °F and °C and vice versa.

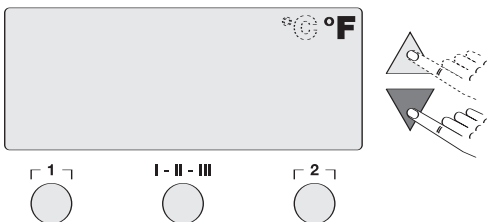

Switch to previous menu item with Radio Button 1. Switch to next menu item with Radio Button I-II-III.

### 7.1.7 Lock Function "🔒"

The Lock Function locks the soldering station control so that no setting changes are possible. Radio Buttons 1, I-II-III, and 2 remain operational in the lock mode. When the lock function is selected in the Special Functions menu, "OFF" and the flashing "🔒" symbol appears in the menu display. If Radio Buttons 1 or I-II-III are depressed while "OFF" appears in the display, no code is saved.

The UP or DOWN Scroll Keys can be used to enter a 1, 2 or 3-digit Lock code. Confirm the code by depressing Radio Button 2 for 5 seconds. The station is now Locked and the "🔒" symbol appears in the main display.

To unlock, activate the Lock Function in Special Functions menu 1. "ON" appears in the display. Enter the code and confirm by depressing Radio Button 2. The station is now unlocked.

Switch to previous menu item with Radio Button 1.

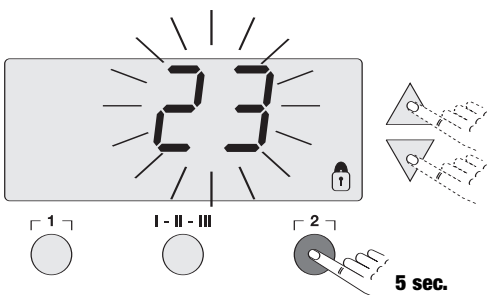

Switch to next menu item with Radio Button I-II-III.

### 7.2 Special Functions Menu 2

Select the desired channel (CH1 or CH2) for inputting the special functions. If the UP and DOWN Scroll Keys are pressed simultaneously, after approximately 4 seconds, the menu selection for the Special Functions is activated and - 2 - appears in the display. Release the

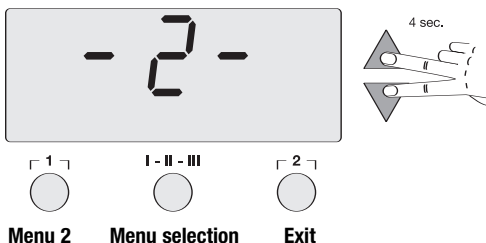

Scroll Keys.

Radio Buttons 1 and I-II-III are used for menu selection.

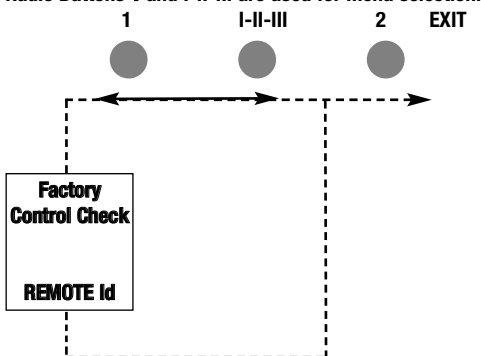

### 7.2.1 Factory Control Check Function ( FCC )

This function checks temperature accuracy of the soldering station and allows modifications if necessary. To perform the "FCC" function, the soldering tip temperature must be measured using an external temperature measuring instrument.

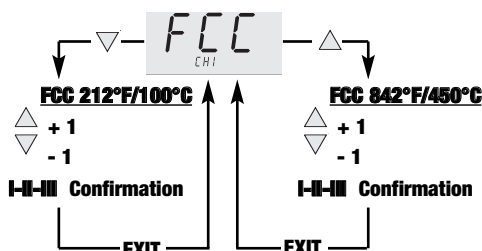

Select the “FCC” High or Low Set point with the **UP** or **DOWN** Scroll Key. After the “FCC” function is complete at both “Set” points, Radio Button **2** is used to exit the menu.

**UP** Scroll Key: High “Set” point 842°F/450°C

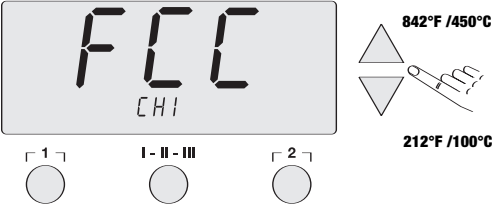

**DOWN** Scroll Key: Low “Set” point 212°F/100°C

**Resetting the Special Functions to Factory Settings**

Press and hold the **2** Radio Button. Then press the **UP** and **DOWN** Scroll Keys at the same time. “FSE”, “Factory Setting Enabled” appears in the display. The station is now reset to its factory default settings.

**Important:**

The soldering tool becomes hot during the Factory Control Check. Never leave combustible materials near the hot soldering iron.

**7.2.2 Adjusting Factory Control Check Settings ( FCC )**

**Control Check at 212°F/100°C**

**Depress the DOWN Scroll Key**

The station sets the temperature of the soldering tip to 212°F/100°C. Once the temperature becomes stable (at which point the indicator flashes), the soldering tip temperature reading on the external device is compared to that shown on the station display. If the temperature readings differ, the **UP/ DOWN** Scroll Keys can be used to make adjustments. The temperature Offset is indicated in the display. A maximum temperature adjustment of  $\pm 72^\circ\text{F}/\pm 40^\circ\text{C}$  is possible. After the measured temperature matches that shown on the station display, depress the Radio Button **I-II-III** to confirm. The temperature Offset is reset to “0”. This concludes the Factory Control Check adjustments at 212°F/100°C.

Press Radio Button **2** to exit the menu without saving

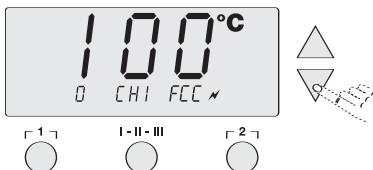

any changes.

**Control Check at 842°F/450°C**

**Depress the UP Scroll Key**

The station sets the temperature of the soldering tip to 842°F/450°C. Once the temperature becomes stable (at which point the indicator flashes), the soldering tip temperature reading on the external device is compared to that shown on the station display. If the temperature readings differ, the **UP/ DOWN** Scroll Keys can be used to make adjustments. The temperature offset is indicated in the display. A maximum temperature adjustment of  $\pm 72^\circ\text{F}/\pm 40^\circ\text{C}$  is possible. After the measured temperature matches that shown on the display, depress the Radio Button **I-II-III** to confirm. The temperature offset is reset to 0. This concludes the Factory Control Check adjustment at 842°F/450°C.

Press Radio Button **2** to exit the menu without saving any changes.

After both control points, 212°F(100°C) and 842°F (450°C), have been set and confirmed, the Factory

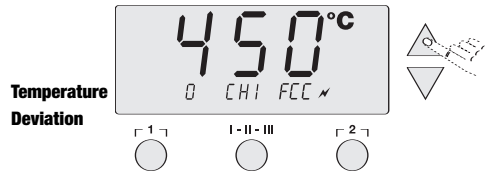

Control Check process is complete.

**7.2.3 Station Code ( ID number )**

When using multiple WD stations, you can assign a number from 0 - 999 to each soldering station for identification purposes.

Use the **UP / DOWN** Scroll Keys to change the ID number.

Switch to previous menu item with Radio Button **1**.

Switch to next menu item with Radio Button **I-II-III**.

Radio Button **2** is used to exit Special Functions Menu

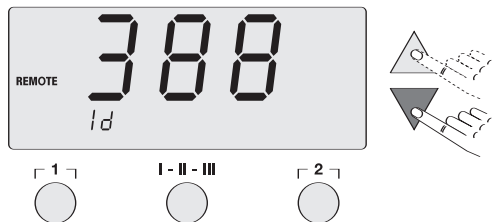

2.

## 8. USB Interface

The WD2M Soldering Station is equipped with a mini USB interface. Weller standard software ( CD included ) has been provided to use the USB port. This software contains a firmware updater and monitor software.

The firmware updater is used to provide a software update, whereby the Soldering Station can be supplied with the most up-to-date software.

The monitor software can be used for remote control of the unit. Temperature curves can be displayed, printed out and saved.

## 9. Operating Guidelines

During initial heat-up, tin the soldering tip with solder to remove oxidation and contamination on the soldering tip. Before placing tool in holder, be sure the soldering tip is well tinned. Use of an aggressive flux will shorten tip life.

The contact surfaces between the heating element/sensor and the soldering tip must not be obstructed. Dirt or foreign materials could cause damage and could affect tip temperature accuracy.

### Handling the Soldering Tips

- Select the lowest working temperature possible.
- Select the largest possible soldering tip for the application. Rule of thumb: approximately as large as the soldering pad.
- Maximize heat transfer between soldering tip and solder joint by tinning the soldering tip.
- To extend tip life, switch the soldering system off, or use the Weller Standby/Setback function to decrease temperature before work breaks or extended periods of non-use.
- Tin the tip before placing the soldering iron in the Tool Holder.
- When making a connection, solder should be applied to the solder joint and not to the tip.
- Where necessary, use the appropriate tool to change the soldering tips.

## 10. Accessories

0052918099	Soldering Pencil, WP80 / 80W, Short Grip
0058744845	Short Grip Tip Retainer, WP80
0058744846	Long Grip Tip Retainer, WP80
WMP	WMP Soldering Pencil, WMP Micro 65W
0053313399	Desoldering Tweezer Set WTA50
0053315199	FE75 / Fume Extraction Pencil, 80W Set
0053313599	Soldering Iron Set WSP150
0051512299	WDH20 Soldering Iron Holder for WMP
0051512199	WDH10 Soldering Iron Holder for WP80/WSP80
0051504299	AK51 Tweezer Stand for WTA50
0052241999	Sponge
0052609899	10' Extension Cordset for WP80 ( Made to Order ) Not Shown

## 11. Packing List

### WD2M

Control Unit  
 120 VAC Power Cord  
 USB Cable  
 CD / Operating Instruction / Software for PC Connection  
 Operating Instructions  
 Safety Information Booklet

### WD2000M

WD2M Control Unit  
 120 VAC Power Cord  
 WMRP Soldering Iron  
 WMRH Soldering Iron Holder for WMRP  
 WMRT Desoldering Tweezers  
 WMRT Tweezer Stand  
 USB Cable  
 CD / Operating Instruction / Software for PC Connection  
 Operating Instructions  
 Safety Information Booklet

Subject to technical change without notice.

## WMRP Iron and Stand

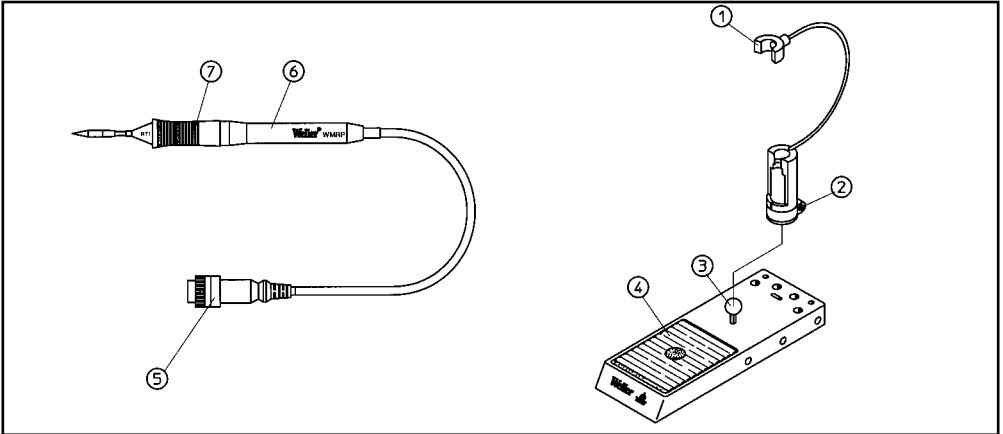

1. Tool holder
2. Ball joint clamping screw
3. Ball joint for setting the tool holder angle
4. Sponge
5. Hand piece connector / plug
6. Soldering iron handle
7. Soldering tip

## Technical Specifications

### Technical Data

Supply Voltage:	24 VAC
Power Rating:	40 W
Heat Up Time:	3 sec. from ambient to 750°F (399°C)
Max. Temp.:	850°F (450°C)
Min. Temp.:	200°F (100°C)
Tool Cord:	Silicone rubber, burn resistant
Connector:	Polarized, 5 pin locking
Tool Weight:	Less than 1/2 ounce
Sensor Type:	Integrated sensor / heater tip cartridge
Tip Type:	RT series

Thank you for placing your trust in our company by purchasing the Weller WMRP Micro-Soldering Pencil. The ergonomic anti-static design, the quick-change plug-in micro-soldering tips, extremely fast tool heat up, and an auto-off feature when placed in the tool holder, provide the superior performance, versatility, and quality established by Weller.

## 1. Cautions and Warnings!

Please read these Operating Instructions and the attached Safety Information carefully prior to initial operation. Failure to observe the safety warnings may result in accident, injury, or risk to health.

The manufacturer shall not be liable for damage resulting from misuse or unauthorized alterations of the equipment.

**Warning:** This product, when used for soldering and similar applications, produces chemicals known to the State of California to cause cancer and birth defects or other reproductive harm.

### Safety Information

- Always place the soldering iron in the original holder
- Remove all inflammable objects from the proximity of the hot soldering tool.
- Use suitable protective clothing. There is a risk of burns from molten solder.
- Never leave the hot soldering iron unattended.
- Never work on electrically live circuits or components.
- Always wear eye protection when working with soldering and desoldering applications.

## 2. Description

An extremely powerful 40 W fine soldering iron with the heating system integrated into the soldering tip. Thanks to a plug-in system, the soldering tip can be changed without tools. The soldering tip temperature is reached rapidly and controlled precisely. Thanks to a sensor installed in the handle, the soldering iron is shut off automatically when it is placed in the WMRH holder.

## 3. Placing into Operation

Place the soldering iron in the WMRH tool stand and ensure that the soldering iron grip is correctly seated against the tool holder ( 1 ). Move all combustible objects away from the soldering iron and the work

area. Insert the connector plug ( 5 ) in the power

supply receptacle and lock it by turning clockwise. Turn the station's power switch "On" and set the desired temperature. When the tool reaches the set temperature, tin the soldering tip with solder.

## 4. Operating Information

### Changing the soldering tip



**Caution, risk of burns!**

Soldering tips must only be changed when cool. The tip change does not require tools. The soldering tip is removed by simply grasping the soft grip of the soldering tip and pulling from the tool. A tip is inserted by pushing the plug end of the tip into the front end receptacle of the hand piece.

### Important:

Always ensure that the soldering tip is properly seated.

When installing a new soldering tip, ensure that the soldering tip is inserted completely up to the stop in a single motion. Operation with a soldering tip that is not completely inserted can cause the tip to malfunction.

During initial heat-up, tin the soldering tip with solder. This removes oxide layers and contamination on the soldering tip. Before placing the tool in the holder, always ensure the soldering tip is well tinned. The use of an aggressive flux may shorten tip life.

Always keep the cleaning sponge ( 4 ) damp. Use only distilled or de-ionized water.

In addition to the information included in this manual, please see the safety manual and the instructions for the applicable power unit.

**Subject to technical change without notice!**

**0054460199 RT1 Needle Tip**



**0054460299 RT2 Fine Point Tip R 0.020" (0,4mm)**

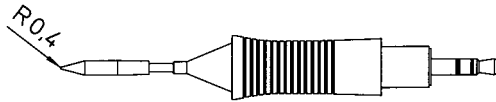

**0054460399 RT3 Chisel Tip 0.050" x 0.020" (1,3mm x 0,4mm)**

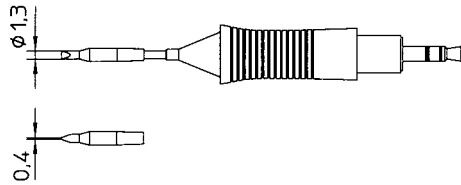

**0054460499 RT4 Chisel Tip 0.060" x 0.020" (1,5mm x 0,4mm)**

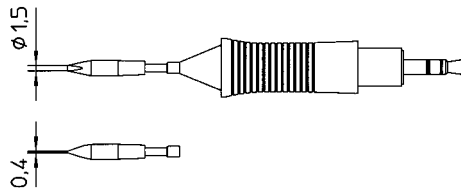

**0054460599 RT5 Chisel Tip 30° bent 0.030" x 0.020" (0,8mm x 0,4mm)**

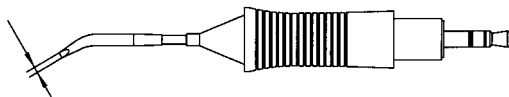

0054460699 RT6 Round Tip 0.050" x 45° (1,2mm x 45°)

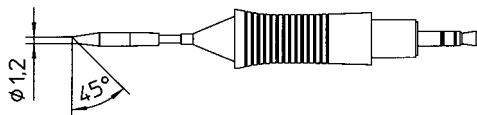

0054460799 RT7 Knife Tip 0.090" x 45° (2,2mm x 45°)

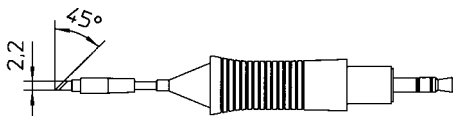

## Replacement Parts and Accessories

KEY NO.	PART NO.	DESCRIPTION
Shown in diagram	0051514599	WMRH Tool Holder for WMRP Soldering Iron
5,6	0052917199	WMRP Pencil, No Tips
4	0052241999	Sponge

For RT series tips see pages 3,4.

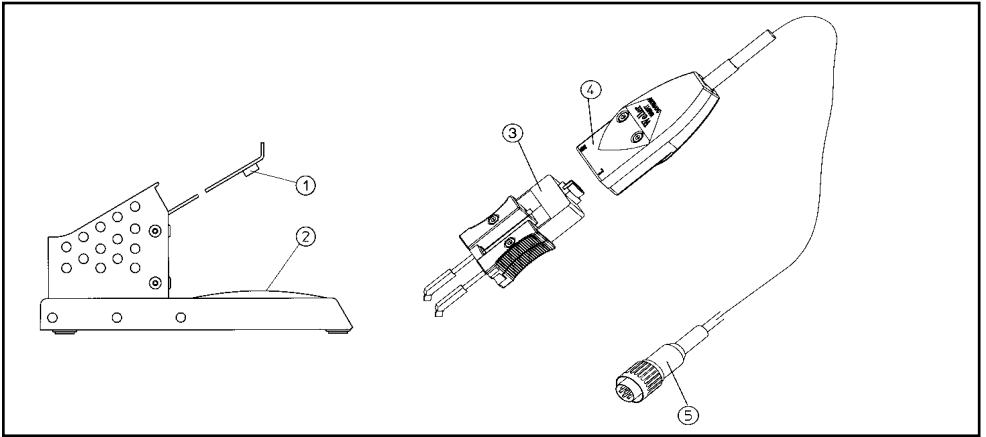

1. Stand / Tool Holder
2. Tip Cleaning Sponge
3. Desoldering Tip Cartridge with Molded Grips
4. Hand Piece
5. Connector / Plug

### Technical Specifications

#### Technical Data

Supply Voltage:	24 VAC
Power Rating:	80 W (2 x 40 W)
Heat Up Time:	3 - 5 sec. (approx.) from ambient to 750°F (399°C)
Max. Temp.:	850°F (450°C)
Min. Temp.:	200°F (100°C)
Tool Cord:	Silicone rubber, burn resistant
Connector:	Polarized, 6 pin locking
Tip Type:	RTW series
Tool Weight:	1.5 ounces without cord

Thank you for placing your trust in our company by purchasing the Weller WMRT Micro Tweezer. The ergonomic anti-static design, selection of desoldering tweezer tips, and 80 watts of power, provide Weller superior performance, versatility, and quality.

## 1. Cautions / Warnings !

Please read these Operating Instructions and the attached Safety Information carefully prior to initial operation. Failure to observe the safety warnings may result in accident, injury, or risk to health.

The manufacturer shall not be liable for damage resulting from misuse or unauthorized alterations of the equipment.

**Warning:** This product, when used for soldering and similar applications, produces chemicals known to the State of California to cause cancer and birth defects or other reproductive harm.

### Safety Information

- Always place the WMRT tweezer in the original holder.
- Remove all inflammable objects from the proximity of the hot desoldering tool.
- Use suitable protective clothing. There is a risk of burns associated with molten solder.
- Never leave the hot WMRT tweezer unattended.
- Never work on electrically live circuits or components.
- Always wear eye protection when working with soldering and desoldering applications.

## 2. Description

The Weller WMRT Tweezers are designed for rework and repair of precision SMT electronic devices. The desoldering tip set can be quickly and easily changed without the use of tools. The tips are pre-aligned and additional alignment is not required. The integrated (2 X 40 W) heating elements ensure that the desoldering tip temperature is reached very quickly and controlled precisely. The desoldering tweezers are switched off automatically when placed in the WMRTH tool holder.

The Weller WMRT Tweezers may only be used with the WD1M or WD2M series power units.

## 3. Placing into Operation

Place the desoldering tweezers ( 4 ) in the tool holder and ensure that the hand piece is correctly seated in

the stand ( 1 ). Move all combustible objects away from the tweezers and the work area. Insert the connector ( 5 ) into the power supply receptacle and lock it by turning clockwise. Turn the station's power switch "On" and set the desired temperature. When the tips have reached the set temperature, tin both tweezer tips with solder.

## 4. Operating Information

### Changing the Desoldering Tips



#### Caution, risk of burns!

Desoldering tips must only be changed when cool. The tip change does not require tools. The desoldering tip cartridge is inserted into the front of the hand piece ( 4 ). The 5-pin mini-plug on the back of the tip cartridge is polarized for correct alignment with the hand piece. The top of the tip cartridge is printed with L (Left) and R (Right) indicators for proper orientation. The indicators align with L and R indicators printed on the hand piece. The tip cartridge ( 3 ) can be removed from the hand piece by grasping the molded grips and pulling outward to release.

#### Important:

Always ensure that the desoldering tip is properly seated.

When installing a new desoldering tip cartridge, ensure that the cartridge is inserted completely against the stop in a single motion. Operation with a desoldering tip that is not completely inserted can cause the tip cartridge to malfunction.

During initial heat up, tin the tips with solder. This removes oxidation and contamination on the desoldering tips. Before placing the tool in the holder, always ensure that the desoldering tips are well tinned. Use of an aggressive flux will possibly shorten tip life.

Always keep the cleaning sponge ( 2 ) damp. Use only distilled or de-ionized water.

In addition to the information included in this manual, please see the safety manual and the instructions for the applicable power unit.

**Subject to technical change without notice!**

## WMRT Tip Cartridge

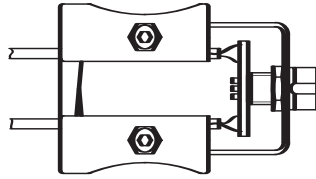

0054465199 RTW1 Tip Set 0,2 mm (.008"), 45°

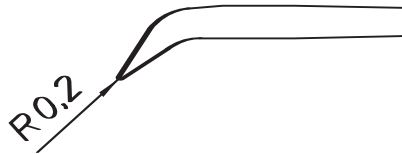

0054465299 RTW2 Tip Set 0,7 x 0,4 mm (.028" x .016"), 45°

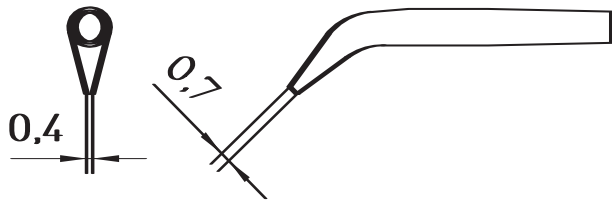

0054465399 RTW3 Tip Set 3 x 0,7 mm (.118" x .028"), 45°

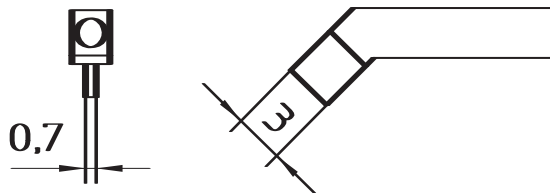

0054465499 RTW4 Tip Set 6 x 0,7 mm (.236" x .028"), 45°

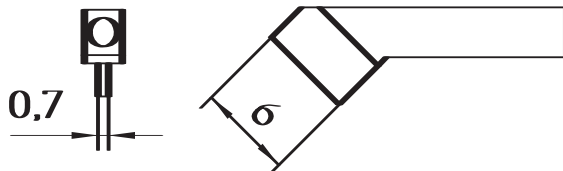

## Replacement Parts and Accessories

<b>KEY NO.</b>	<b>PART NO.</b>	<b>DESCRIPTION</b>
1,2	0051514699	WMRTH Tool Holder / Stand
2	0052241999	Sponge
3,4,5	0051317299	WMRT Micro Tweezers with RTW2 Tip Set
1,2,3,4,5	0051317399	WMRT Micro Tweezers with WMRTH Stand and RTW2 Tip Set

\*For Desoldering Tip Cartridges see page 3.

# WD2M Circuit Diagram

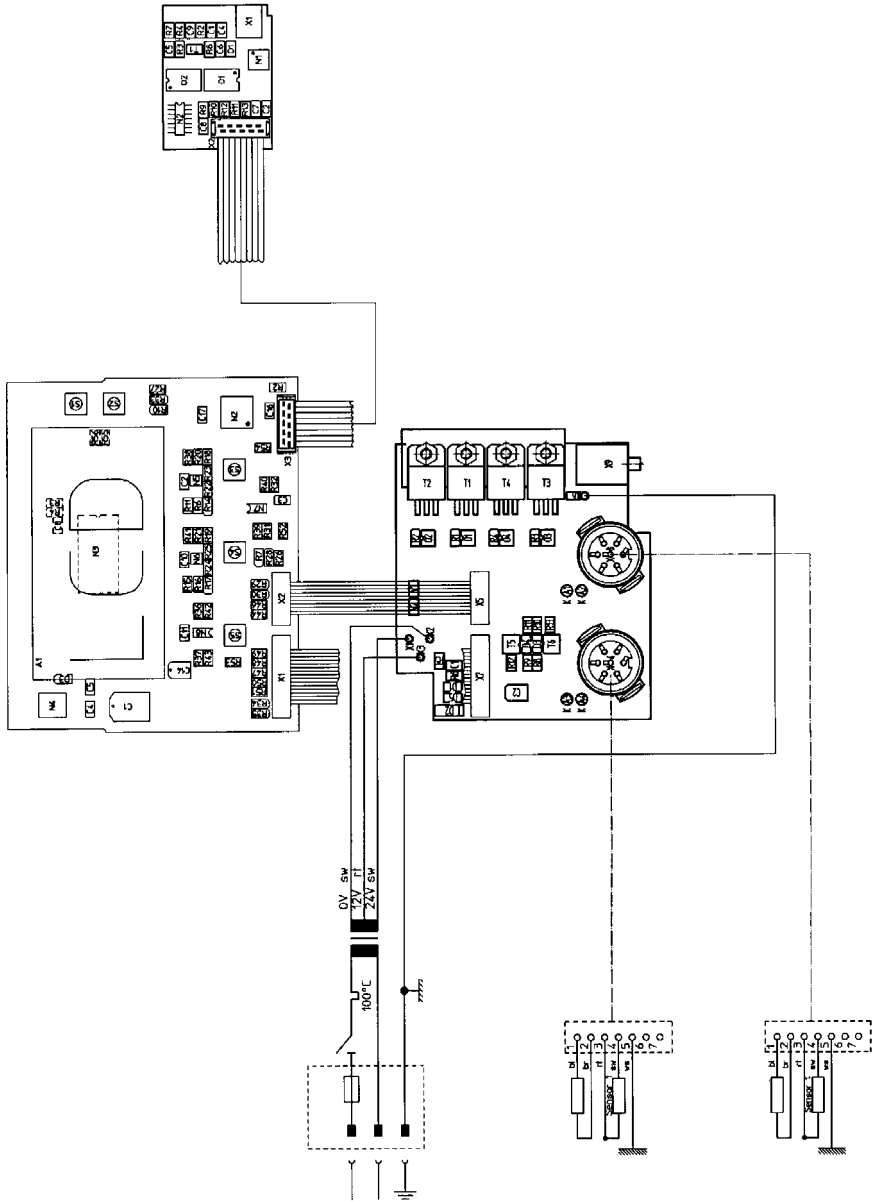

## WD2M Exploded View

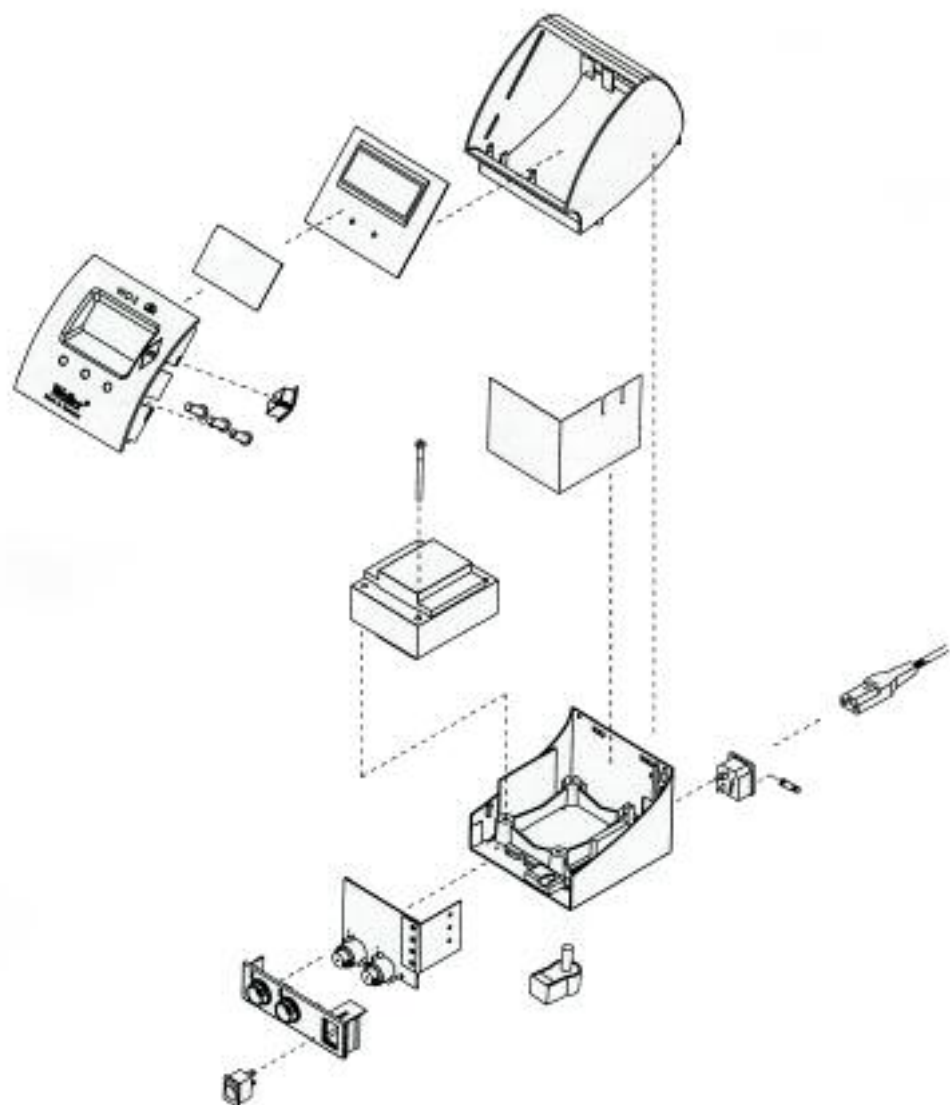



**COOPER** Hand Tools

[www.cooperhandtools.com](http://www.cooperhandtools.com)

**U.S Mailing Address:**

**Cooper Hand Tools**

P.O. Box 728

Apex, NC 27502-0728

**U.S Shipping Address:**

1000 Lufkin Road

Apex, N.C. 27539

Tel: (919) 387-0099

Fax: (919) 387-2379

For inquiries concerning Technical /

Customer Service please call:

(800) 476-3030 Ext. 1

**Canada Shipping Address:**

**Cooper Tools**

164 Innisfil Street

Barrie, Ontario

Canada L4N 3B7

Attn: Repairs

Fax: 1-800-403-TOOL (8665)

Phone: 705-728-5564 Ext. 2026

Weller is a registered Trademark and registered Design of Cooper Industries, Inc.